

RK-1e / RK-1b Single Console



Drawer Features & Benefits

- ▶ Keyboard drawer with full range KVM options
- ▶ 104-key keyboard with either touchpad or trackball
- ▶ MAC or SUN Micro keyboard options available
- ▶ Enhanced aesthetics with molded front handle and two point lock
- ▶ USB Interface for keyboard drawer



Diagrams (mm)

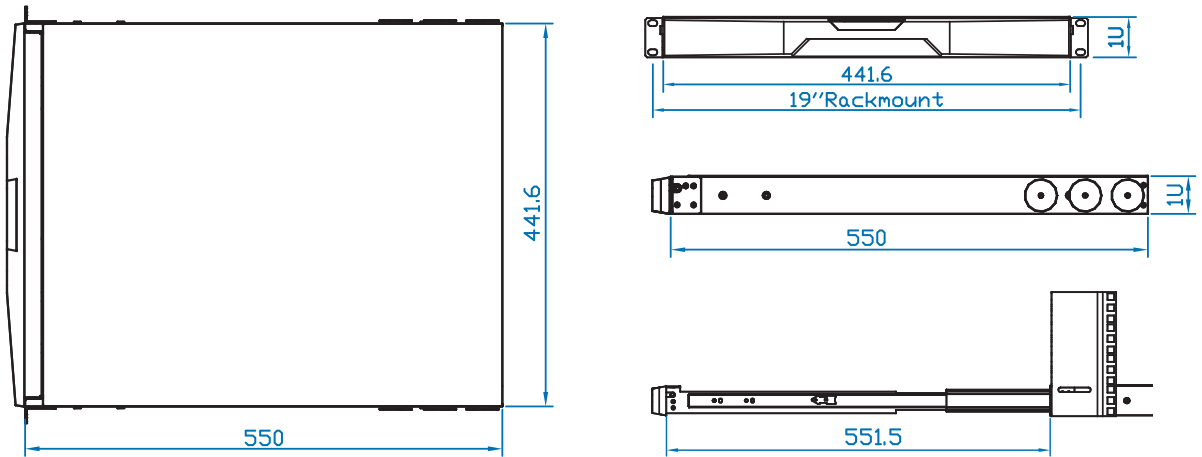

Keyboard Mouse Cable

EKC-2

- 6 feet USB keyboard mouse cable (bundle)
- USB, server end
- DB15 (USB KB & MS), console port

or

EKC-3 (for PS/2 KB / MS)

- 6 feet Combo keyboard mouse cable (alternative)
- USB or PS/2, server end
- DB15 (Combo KB & MS), console port

Standard Keyboard

Ge G keyboard integrated with touchpad

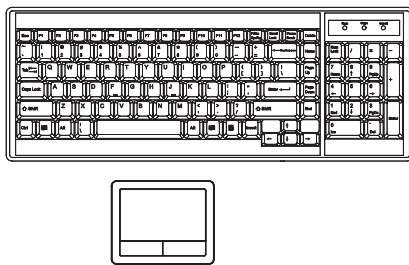

Gb G keyboard integrated with trackball

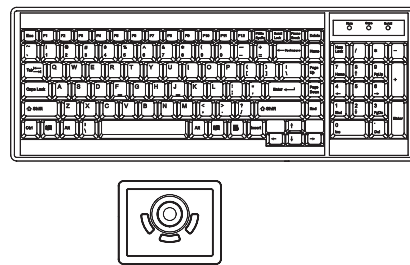

Supporting layouts

America	United States				
EMEA	United Kingdom	Germany	France	Spain	Norway
	Italy	Russia	Switzerland	Netherlands	Portugal
Asia	China	Japan	Korea	Arabia	Turkey

Keyboard Options

* US layout only

Me Mac keyboard with touchpad



Se S keyboard with touchpad

Mb Mac keyboard with trackball

Sb S keyboard with trackball





- **Dimensions (Single console / with KVM)**
 Product : 441.6 x 550 x 44 mm / 17.4 x 21.7 x 1.73 inch
 Packing : 574 x 743 x 95 mm / 22.6 x 29.3 x 3.7 inch
- **Weight (Net / Gross)**
 Console : 10.4 kgs (22.9 lbs) / 13.1 kgs (28.8 lbs)
 KVM : 11.4 kgs (25.1 lbs) / 14.1 kgs (31 lbs)
- **Casing Color :** Black (RAL 9005)

www.austin-hughes.com/support/usermanual/cyberview/UM-CV-UKVM-KIT.pdf

X stands for e or b keyboard.

Combo Cat6 KVM		Local	Remote	TP	8-port	16-port	32-port
		1	0	1	RK - UIP802x	RK - UIP1602x	RK - UIP3202x
		1	1	0	RK - U802x	RK - U1602x	RK - U3202x
		1	0	0	RK - U801x	RK - U1601x	RK - U3201x

Cat6 KVM Dongle : DG-100S (VGA-USB) / DG-100 (VGA-PS/2) / DG-100SD (DVI-USB)

www.austin-hughes.com/support/usermanual/cyberview/UM-CV-SKVM-KIT.pdf

Combo DB-15 KVM		Local	Remote	TP	8-port	16-port	32-port
		1	0	1	RK - IP802x	RK - IP1602x	-
		1	1	0	RK - 802x	RK - 1602x	-
		1	0	0	RK - S801x	RK - S1601x	-

USB KVM Cable : CB-6 / 10 / 15 (6, 10 or 15 ft)

www.austin-hughes.com/support/usermanual/cyberview/UM-CV-DVIKVM-KIT.pdf

DVI-D KVM		Local	Remote	TP	12-port	-	-
		1	0	0	RK - 1201Dx	-	-

DVI-D KVM Cable : CI-6 / 15 (6 or 15 ft)

www.austin-hughes.com/support/usermanual/cyberview/UM-CV-PS2KVM-KIT.pdf

PS/2 DB-15 KVM		Local	Remote	TP	8-port	-	-
		1	0	0	RK - 801x	-	-

PS/2 DB-15 KVM Cable : CD-6 / 15 (6 or 15 ft)